



90W Constant Current Mode LED Driver

LPF-90D series



■ Features

- Constant Current mode output
- Plastic housing with Class II design
- Built-in active PFC function
- Class 2 power unit
- IP67 rating for indoor or outdoor installations
- Function: 3 in 1 dimming
- Typical lifetime > 50000 hours
- 5 years warranty

■ Applications

- LED panel lighting
- LED downlight
- LED decorative lighting
- LED tunnel lighting
- Moving sign
- Type "HL" for use in Class I, Division 2 hazardous (Classified) location.

■ Description

LPF-90D series is a 90W AC/DC LED driver featuring the constant current output. LPF-90D operates from 90~305VAC and offers models with different rated voltage ranging between 15V and 54V. Thanks to the high efficiency up to 90.5%, with the fanless design, the entire series is able to operate for -40°C ~ +70°C case temperature under free air convection. The entire series is rated with IP67 ingress protection level and is suitable to work for a variety of applications at dry, damp or wet locations. LPF-90D is equipped with the 3 in 1 dimming function so as to provide the design flexibility for LED lighting system.

■ Model Encoding

LPF - 90D - 24

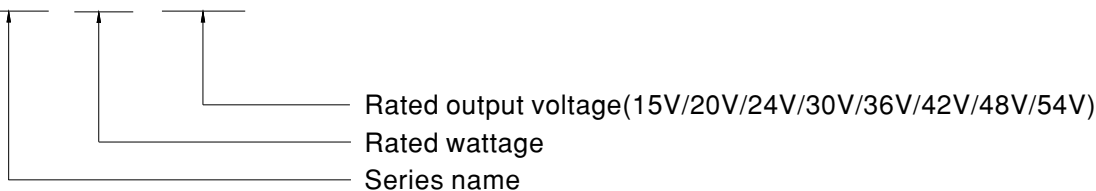



90W Constant Current Mode LED Driver

LPF-90D series

SPECIFICATION

MODEL	LPF-90D-15	LPF-90D-20	LPF-90D-24	LPF-90D-30	LPF-90D-36	LPF-90D-42	LPF-90D-48	LPF-90D-54	
OUTPUT	DC VOLTAGE	15V	20V	24V	30V	36V	42V	48V	54V
	RATED CURRENT	5A	4.5A	3.75A	3A	2.5A	2.15A	1.88A	1.67A
	RATED POWER <small>Note.5</small>	75W	90W	90W	90W	90W	90.3W	90.24W	90.18W
	CONSTANT CURRENT REGION <small>Note.2</small>	9 ~ 15V	12 ~ 20V	14.4 ~ 24V	18 ~ 30V	21.6 ~ 36V	25.2 ~ 42V	28.8 ~ 48V	32.4 ~ 54V
	CURRENT RIPPLE	5.0% max. @rated current							
	CURRENT TOLERANCE	±5.0%							
	SETUP, RISE TIME <small>Note.6</small>	1200ms, 200ms / 115VAC 500ms, 200ms / 230VAC							
	HOLD UP TIME (Typ.)	16ms/230VAC 16ms/115VAC							
INPUT	VOLTAGE RANGE <small>Note.5</small>	90 ~ 305VAC 127 ~ 431VDC (Please refer to "STATIC CHARACTERISTIC" section)							
	FREQUENCY RANGE	47 ~ 63Hz							
	POWER FACTOR	PF ≥ 0.97/115VAC, PF ≥ 0.96/230VAC, PF ≥ 0.95/277VAC@full load (Please refer to "POWER FACTOR (PF) CHARACTERISTIC" section)							
	TOTAL HARMONIC DISTORTION	THD < 20% (@load ≥ 60%/115VAC, 230VAC; @load ≥ 75%/277VAC) (Please refer to "TOTAL HARMONIC DISTORTION (THD)" section)							
	EFFICIENCY (Typ.)	89%	89.5%	90%	90.5%	90.5%	90.5%	90.5%	90.5%
	AC CURRENT	0.95A / 115VAC 0.5A / 230VAC 0.4A / 277VAC							
	INRUSH CURRENT (Typ.)	COLD START 70A (twidth=435µs measured at 50% Ipeak) at 230VAC; Per NEMA 410							
	MAX. No. of PSUs on 16A CIRCUIT BREAKER	4 units (circuit breaker of type B) / 6 units (circuit breaker of type C) at 230VAC							
PROTECTION	LEAKAGE CURRENT	<0.75mA / 240VAC							
	OVER CURRENT	95 ~ 108% Constant current limiting, recovers automatically after fault condition is removed							
	OVER VOLTAGE	18 ~ 21V	23 ~ 27V	28 ~ 34V	34 ~ 38V	41 ~ 46V	47 ~ 53V	54 ~ 60V	59 ~ 65V
	OVER TEMPERATURE	Shut down o/p voltage, re-power on to recover							
ENVIRONMENT	WORKING TEMP.	Tcase=-40 ~ +70°C (Please refer to " OUTPUT LOAD vs TEMPERATURE" section)							
	MAX. CASE TEMP.	Tcase=+70°C							
	WORKING HUMIDITY	20 ~ 95% RH non-condensing							
	STORAGE TEMP., HUMIDITY	-40 ~ +80°C, 10 ~ 95% RH							
	TEMP. COEFFICIENT	±0.03%/°C (0 ~ 50°C)							
	VIBRATION	10 ~ 500Hz, 5G 12min./1cycle, period for 72min. each along X, Y, Z axes							
SAFETY & EMC	SAFETY STANDARDS <small>Note.8</small>	UL8750(type"HL"), CSA C22.2 No.250.13-12, TUV EN61347-1, EN61347-2-13, EAC TP TC 004, GB19510.1, GB19510.14, IP67 approved; Design refer to UL60950-1, TUV EN60950-1							
	WITHSTAND VOLTAGE	I/P-O/P: 3.75KVAC							
	ISOLATION RESISTANCE	I/P-O/P: 100M Ohms / 500VDC / 25°C / 70% RH							
	EMC EMISSION <small>Note.8</small>	Compliance to EN55015, EN61000-3-2 Class C (@load ≥ 60%); EN61000-3-3, GB17743 and GB17625.1, EAC TP TC 020							
	EMC IMMUNITY	Compliance to EN61000-4-2, 3, 4, 5, 6, 8, 11; EN61547, light industry level (surge immunity Line-Line 2KV), EAC TP TC 020							
OTHERS	MTBF	1036.4K hrs min. Telcordia SR-332 (Bellcore); 267.2Khrs min. MIL-HDBK-217F (25°C)							
	DIMENSION	161*61*36mm (L*W*H)							
	PACKING	0.7Kg; 20pcs/15Kg/0.73CUFT							
NOTE	<ol style="list-style-type: none"> All parameters NOT specially mentioned are measured at 230VAC input, rated current and 25°C of ambient temperature. Please refer to "DRIVING METHODS OF LED MODULE". Ripple & noise are measured at 20MHz of bandwidth by using a 12" twisted pair-wire terminated with a 0.1µf & 47µf parallel capacitor. Tolerance : includes set up tolerance, line regulation and load regulation. De-rating may be needed under low input voltages. Please refer to "STATIC CHARACTERISTIC" sections for details. Length of set up time is measured at first cold start. Turning ON/OFF the driver may lead to increase of the set up time. The driver is considered as a component that will be operated in combination with final equipment. Since EMC performance will be affected by the complete installation, the final equipment manufacturers must re-qualify EMC Directive on the complete installation again. To fulfill requirements of the latest ErP regulation for lighting fixtures, this LED driver can only be used behind a switch without permanently connected to the mains. This series meets the typical life expectancy of >50,000 hours of operation when Tcase, particularly (Tc) point (or TMP, per DLC), is about 70°C or less. Please refer to the warranty statement on MEAN WELL's website at http://www.meanwell.com The ambient temperature derating of 3.5°C/1000m with fanless models and of 5°C/1000m with fan models for operating altitude higher than 2000m(6500ft). For any application note and IP water proof function installation caution, please refer our user manual before using. https://www.meanwell.com/Upload/PDF/LED_EN.pdf 								



90W Constant Current Mode LED Driver

LPF-90D series

■ BLOCK DIAGRAM

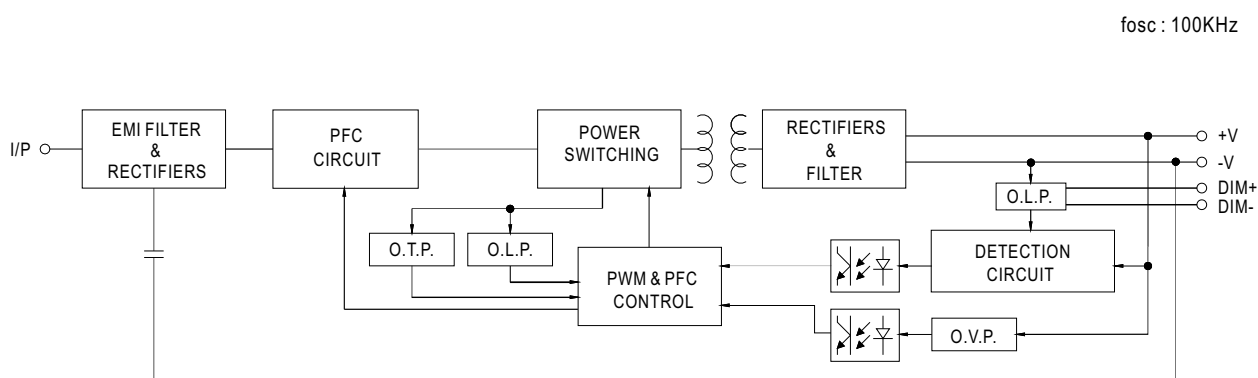

■ DRIVING METHODS OF LED MODULE

※ This series works in constant current mode to directly drive the LEDs.

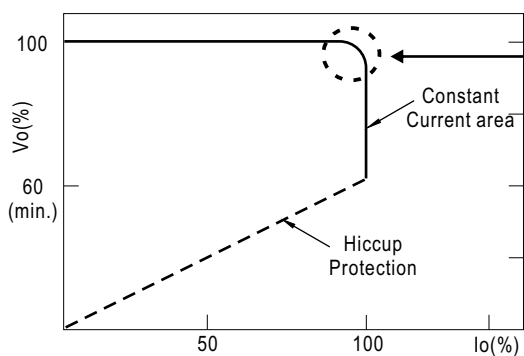

Typical output current normalized by rated current (%)

In the constant current region, the highest voltage at the output of the driver depends on the configuration of the end systems.
Should there be any compatibility issues, please contact MEAN WELL.



90W Constant Current Mode LED Driver

LPF-90D series

■ DIMMING OPERATION

※ 3 in 1 dimming function

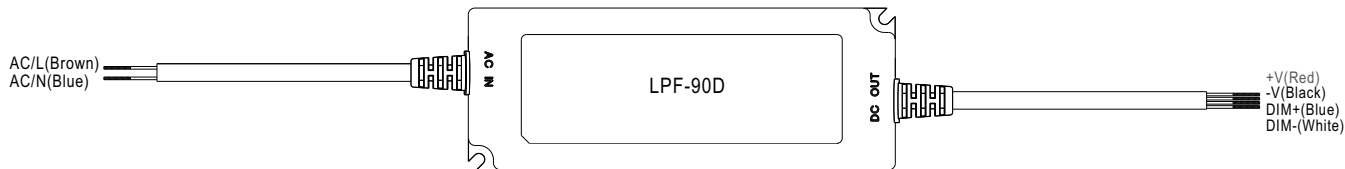

- Output constant current level can be adjusted by applying one of the three methodologies between DIM+ and DIM-: 1 ~ 10VDC, or 10V PWM signal or resistance.
- Direct connecting to LEDs is suggested. It is not suitable to be used with additional drivers.
- Dimming source current from power supply: 100 μ A (typ.)

◎ Applying additive 1 ~ 10VDC

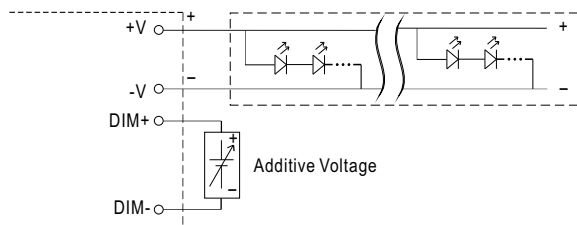

"DO NOT connect "DIM- to -V"

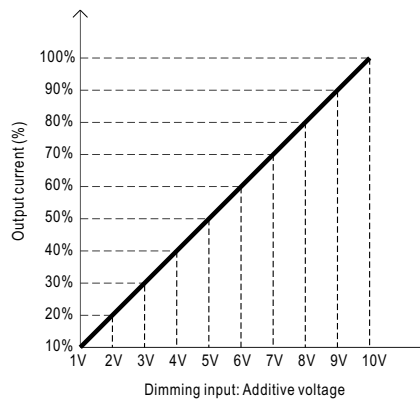

◎ Applying additive 10V PWM signal (frequency range 100Hz ~ 3KHz):

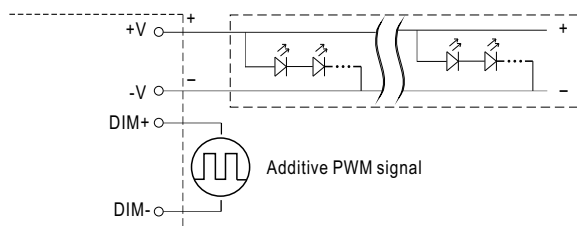

"DO NOT connect "DIM- to -V"

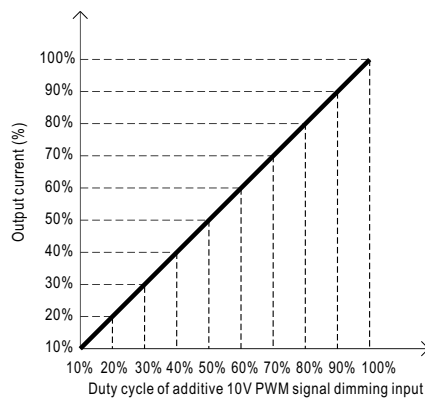

◎ Applying additive resistance:

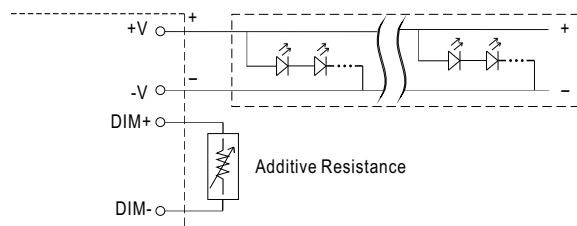

"DO NOT connect "DIM- to -V"

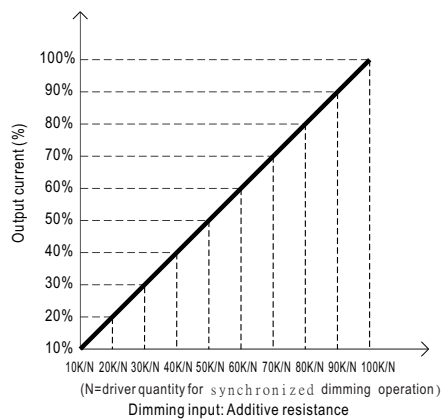



90W Constant Current Mode LED Driver

LPF-90D series

Note: In the case of turning the lighting fixture down to 0% brightness, please refer to the configuration as follow, or please contact MEAN WELL for other options.

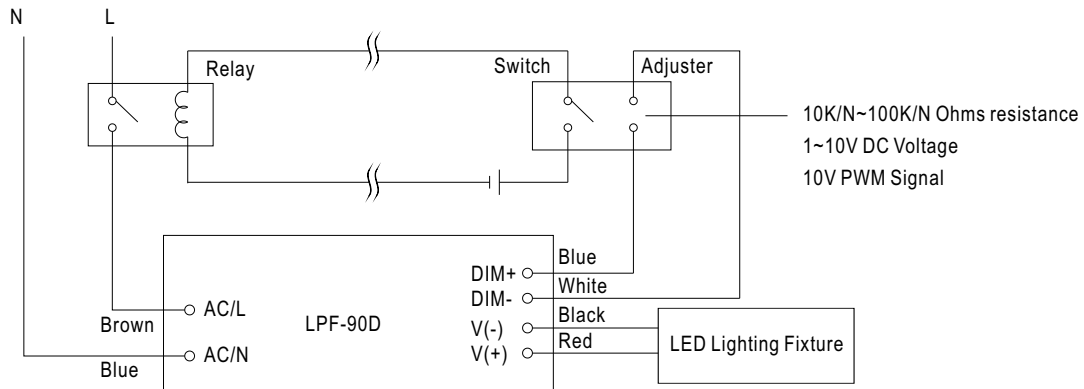

Using a switch and relay can turn ON/OFF the lighting fixture.



OUTPUT LOAD vs TEMPERATURE

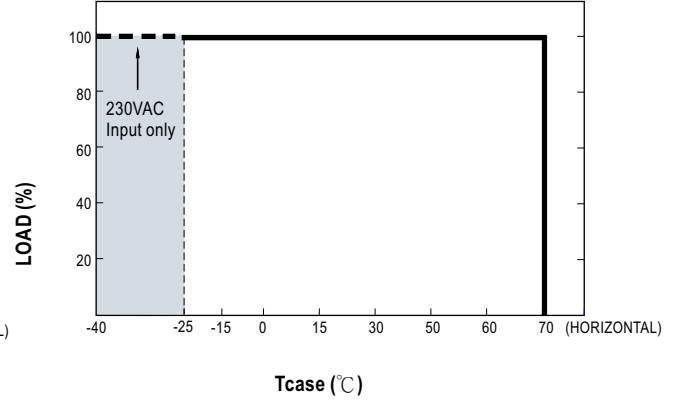
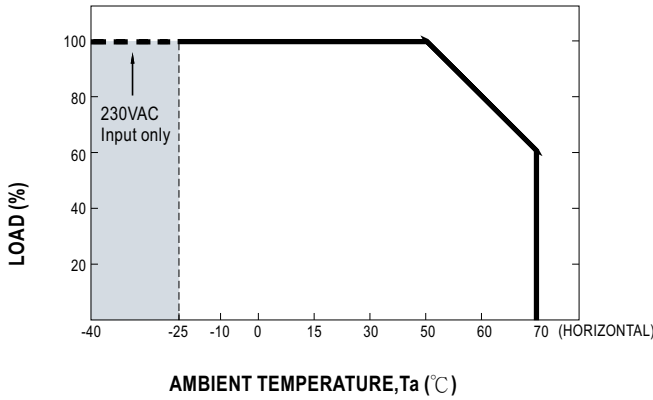

STATIC CHARACTERISTIC

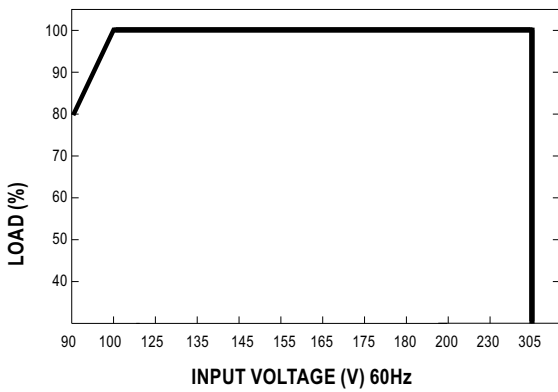

※ De-rating is needed under low input voltage.

POWER FACTOR (PF) CHARACTERISTIC

※ T_{case} at 60°C

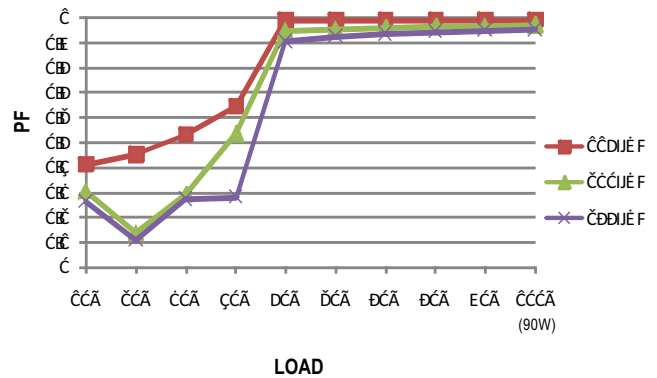

TOTAL HARMONIC DISTORTION (THD)

※ 48V Model, T_{case} at 60°C

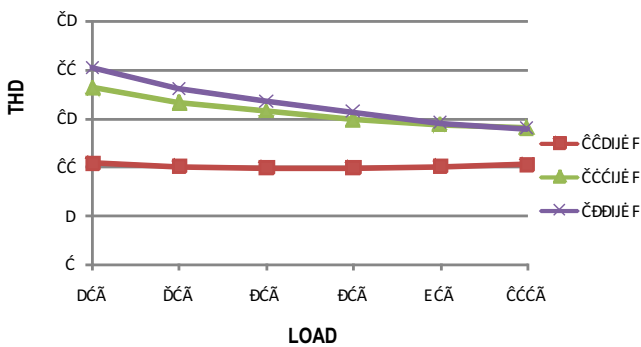

EFFICIENCY vs LOAD

LPF-90D series possess superior working efficiency that up to 90.5% can be reached in field applications.

※ 48V Model, T_{case} at 60°C

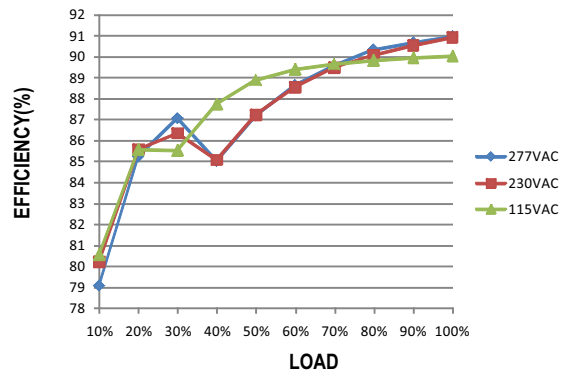



90W Constant Current Mode LED Driver

LPF-90D series

■ LIFE TIME

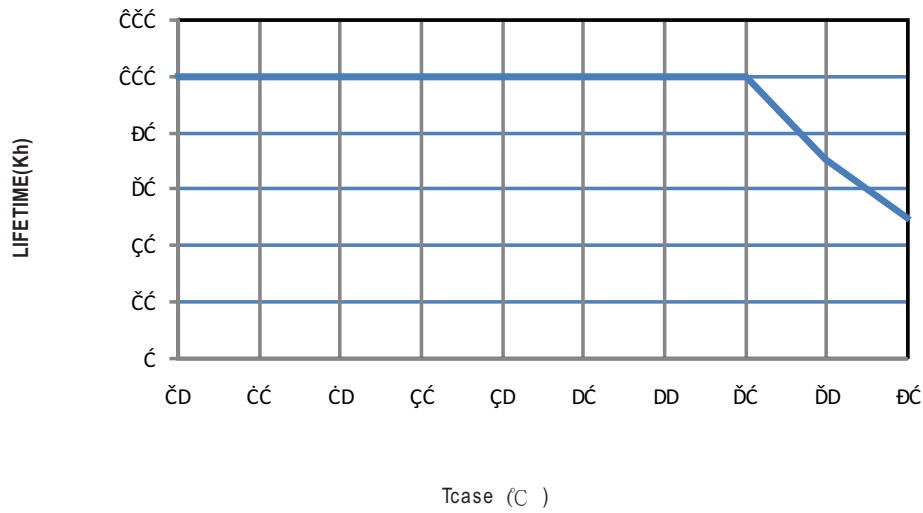



90W Constant Current Mode LED Driver

LPF-90D series

■ MECHANICAL SPECIFICATION

CASE NO.: LPF-90A Unit:mm

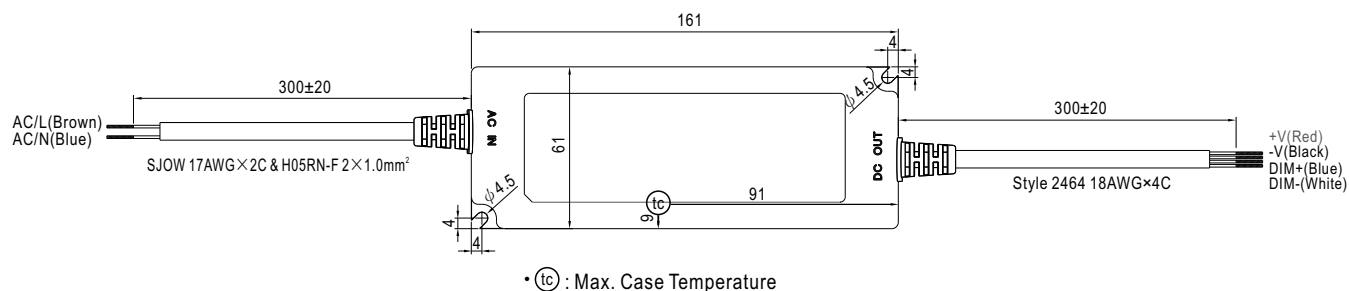

• (tc) : Max. Case Temperature



■ Recommend Mounting Direction



■ INSTALLATION MANUAL

Please refer to : <http://www.meanwell.com/manual.html>